



PRODUCT SPECIFICATIONS

For Customer: _____

 : APPROVAL FOR SPECIFICATION

Customer Model No. _____

 : APPROVAL FOR SAMPLE

 Module No.: PV05027D0131Y
Date : 2021-8-15

Table of Contents

No.	Item	Page
1	Cover Sheet(Table of Contents)	
2	Revision Record	
3	General Specifications	
4	Outline Drawing	
5	Absolute Maximum Ratings	
6	Electrical Specifications	
7	Optical Characteristics	
8	Reliability Test Items and Criteria	
9	Precautions for Use of LCD Modules	

For Customer's Acceptance:

Approved By	Comment

PREPARED	CHECKED	VERIFIED BY QA DEPT	VERIFIED BY R&D DEPT



3. General Specifications

PV05027D0131Y is a TFTLCD FT-module. It is composed of a TFTLCD panel, driver IC, FPC, a back light unit. The 4.97" display area contains 1080 x 1920 pixels and can display up to 16.7M colors. This product accords with RoHS environmental criterion.

Item	Contents	Unit	Note
LCD Type	TFT	-	
Display color	16.7M		
Viewing Direction	ALL	0'Clock	
Operating temperature	-10~+60	°C	
Storage temperature	-20~+70	°C	
Module size	Refer to outline drawing	mm	
Active Area(W×H)	61.64X109.58	mm	
Number of Dots	1080×1920	dots	
Controller	HX8399C	-	
Power Supply Voltage	1.65-3.3	V	
Outline Dimensions	Refer to outline drawing	-	
Backlight	6X2-LEDs (white)	PCS	
Weight	-	g	
Interface	MIPI	-	



5. Absolute Maximum Ratings($T_a=25^\circ\text{C}$)

5.1 Electrical Absolute Maximum Ratings.($V_{SS}=0\text{V}$, $T_a=25^\circ\text{C}$)

Item	Symbol	Min.	TYP.	Max.	Unit	Note
I/O and Logic power supply	IOVCC	1.65	1.8	3.3	V	1, 2
Positive source driver power	AVDD	4.8	5.5	6	V	
Negative source driver power	AVEE	-6	-5.5	-4.8	V	

Notes:

1. If the module is above these absolute maximum ratings. It may become permanently damaged. Using the module within the following electrical characteristic conditions are also exceeded, the module will malfunction and cause poor reliability.
2. $V_{DD} > V_{SS}$ must be maintained.
3. Please be sure users are grounded when handing LCD Module.

5.2 Environmental Absolute Maximum Ratings.

Item	Storage		Operating		Note
	MIN.	MAX.	MIN.	MAX.	
Ambient Temperature	-30°C	80°C	-20°C	70°C	1,2
Humidity	-	-	-	-	3

1. The response time will become lower when operated at low temperature.
2. Background color changes slightly depending on ambient temperature.
The phenomenon is reversible.
3. $T_a \leq 40^\circ\text{C}$: 85%RH MAX.
 $T_a > 40^\circ\text{C}$: Absolute humidity must be lower than the humidity of 85%RH at 40°C .



6. Electrical Specifications and Instruction Code

6.1 Electrical characteristics(VSS=0V ,Ta=25°C)

6.2 LED backlight specification(VSS=0V ,Ta=25°C)

Item	Symbol	Condition	Min	TYP	Max	Unit	Note
Supply voltage	V _f	If=2X20mA	-	19.2	-	V	
Uniformity	Δ Bp	If=2X20mA	80	-	-	%	

Note:

1 : The "LED Life time" is defined as the module brightnees decrease to 50% original brightness at T=25°C and I_{LED}=40mA. TheLED Life time could be decreased if operating I_{LED} is larger than 40mA

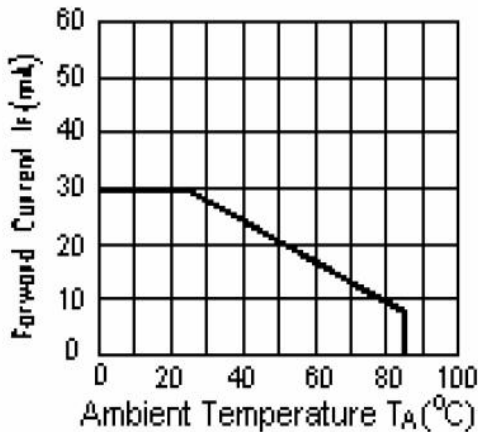

I_{LED} VS TEMP



6.3 Interface signals

Pin No.	Symbol	I/O	Function
1	LEDA1	P	LED anode
2	LEDA2	P	LED anode
3	LEDK1	P	LED cathode
4	LEDK2	P	LED cathode
5	NC		No connection
6	GND	P	Ground
7	TE	O	Serves TE (Tearing Effect) output pin
8	NC		No connection
9	IOVCC	P	I/O and Logic power supply
10	AVDD	P	Positive source driver power (External input mode VSP)
11	AVEE	P	Negative source driver power (External input mode VSN)
12	LEDPWM	O	The PWM frequency output for LCD driver control
13	RESET	I	The external reset input
14	GND	P	Ground
15	NC		No connection
16	GND	P	Ground
17	D2P	I	MIPI-DSI Data differential signal input pins. (Data lane 2)
18	D2N	I	MIPI-DSI Data differential signal input pins. (Data lane 2)
19	GND	P	Ground
20	D1P	I	MIPI-DSI Data differential signal input pins. (Data lane 1)
21	D1N	I	MIPI-DSI Data differential signal input pins. (Data lane 1)
22	GND	P	Ground
23	CLKP	I	MIPI-DSI CLOCK differential signal input pins.
24	CLKN	I	MIPI-DSI CLOCK differential signal input pins.
25	GND	P	Ground
26	D0P	I/O	MIPI-DSI Data differential signal input pins. (Data lane 0)
27	D0N	I/O	MIPI-DSI Data differential signal input pins. (Data lane 0)
28	GND	P	Ground
29	D3P	I	MIPI-DSI Data differential signal input pins. (Data lane 3)
30	D3N	I	MIPI-DSI Data differential signal input pins. (Data lane 3)
31	GND	P	Ground



7. Optical Characteristics

Item	Symbol	Condition	Min.	Typ.	Max.	Unit	Note
Brightness	Bp	$\theta=0^\circ$	-	TBD	-	Cd/m ²	1
Uniformity	ΔBp	$\Phi=0^\circ$	80	-	-	%	1,2
Viewing Angle	3:00	Cr \geq 10	-	80	-	Deg	3
	6:00		-	80	-		
	9:00		-	80	-		
	12:00		-	80	-		
Contrast Ratio	Cr	$\theta=0^\circ$ $\Phi=0^\circ$	-	1500	-	-	4
Response Time	T _r		-	12	-	ms	5
	T _f		-	12	-	ms	
Color of CIE Coordinate	W	x	$\theta=0^\circ$ $\Phi=0^\circ$	0.300	-	1,6	
		y		0.338	-		
	R	x		0.632	-		
		y		0.313	-		
	G	x		0.302	-		
		y		0.597	-		
	B	x		0.143	-		
		y		0.137	-		
NTSC Ratio	S	-	60	-	%		

Note: The parameter is slightly changed by temperature, driving voltage and materiel

Note 1: The data are measured after LEDs are turned on for 5 minutes. LCM displays full white. The brightness is the average value of 5 measured spots. Measurement equipment BM-7 (Φ 5mm)

Measuring condition:

- Measuring surroundings: Dark room.
- Measuring temperature: Ta=25 °C.
- Adjust operating voltage to get optimum contrast at the center of the display.



Measured value at the center point of LCD panel after more than 5 minutes while backlight turning on.

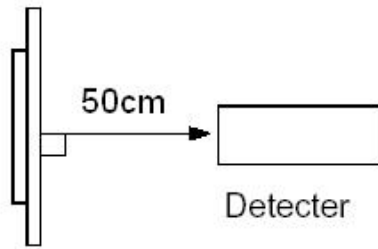

Note 2: The luminance uniformity is calculated by using following formula.

$$\Delta Bp = Bp (\text{Min.}) / Bp (\text{Max.}) \times 100 (\%)$$

$Bp (\text{Max.})$ = Maximum brightness in 5 measured spots

$Bp (\text{Min.})$ = Minimum brightness in 5 measured spots.

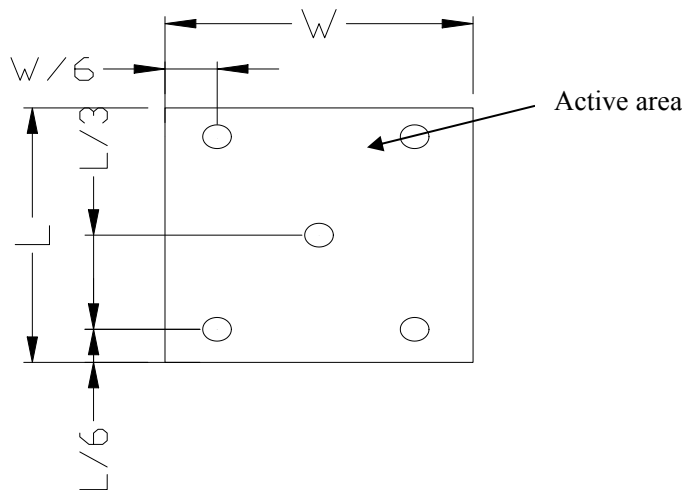

Note 3: The definition of viewing angle:

Refer to the graph below marked by ϑ and Φ

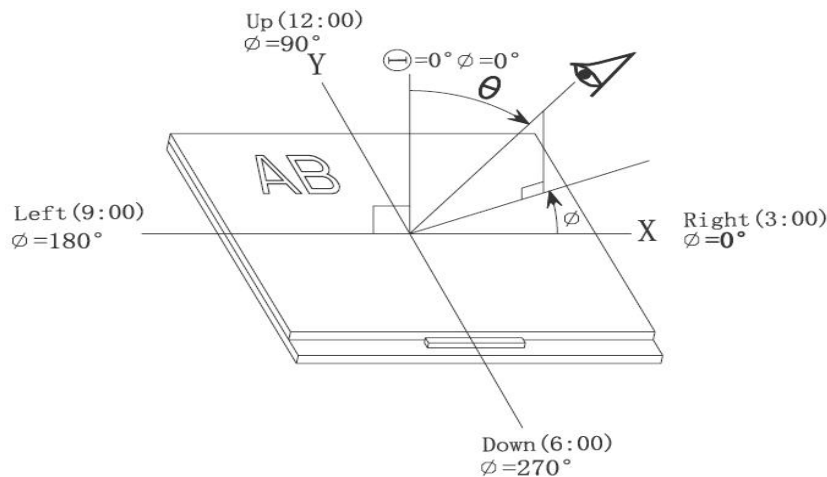



Note 4: Definition of contrast ratio.(Test LCD using DMS501)

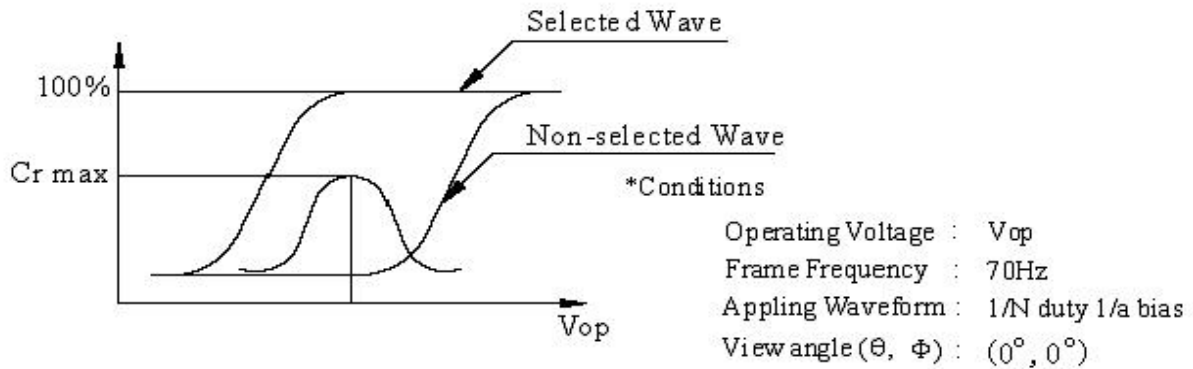

$$\text{Contrast ratio}(Cr) = \frac{\text{Brightness of selected dots}}{\text{Brightness of non-selected dots}}$$

Note 5: Definition of Response time. (Test LCD using DMS501):

The output signals of photo detector are measured when the input signals are changed from "black" to "white"(falling time) and from "white" to "black"(rising time), respectively. The response time is defined as the time interval between the 10% and 90% of amplitudes. Refer to figure as below.

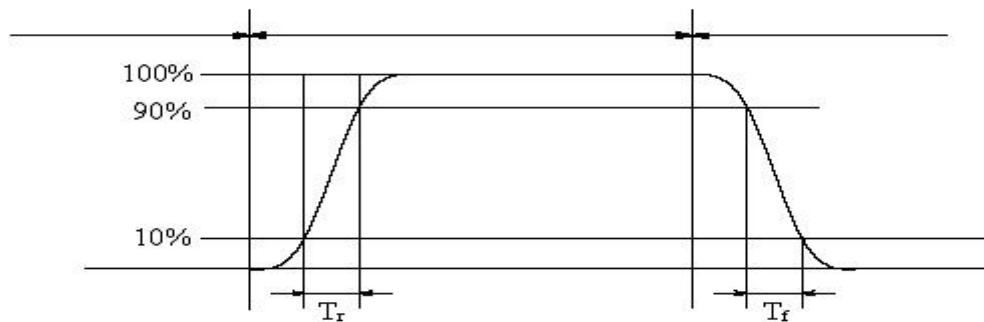

The definition of response time

Note 6: Definition of Color of CIE Coordinate and NTSC Ratio.

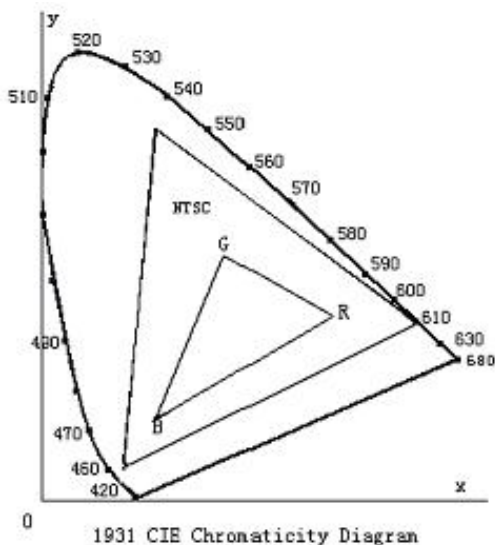

Color gamut:

$$S = \frac{\text{area of RGB triangle}}{\text{area of NTSC triangle}} \times 100\%$$



Note 7: Definition of cross talk.

$$\text{Cross talk ratio(\%)} = \frac{|\text{pattern A Brightness} - \text{pattern B Brightness}|}{\text{pattern A Brightness}} * 100$$

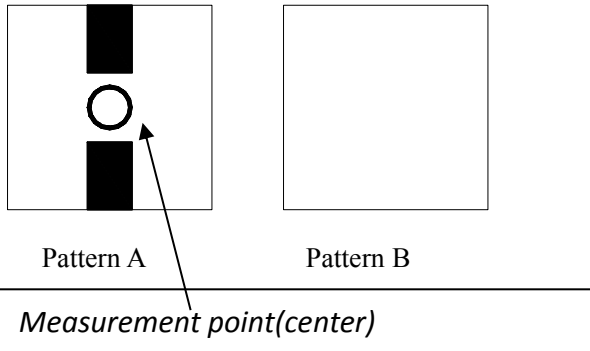

Electric volume value=3F+/-3Hex



8. Reliability Test Items and Criteria

No	Test Item	Test condition	Criterion
1	High Temperature Storage	80°C±2°C 96H Restore 2H at 25°C Power off	1. After testing, cosmetic and electrical defects should not happen. 2. Total current consumption should not be more than twice of initial value.
2	Low Temperature Storage	-30°C±2°C 96H Restore 2H at 25°C Power off	
3	High Temperature Operation	70°C±2°C 96H Restore 2H at 25°C Power on	
4	Low Temperature Operation	-20°C±2°C 96H Restore 4H at 25°C Power on	
5	High Temperature/Humidity Operation	60°C±2°C 90%RH 96H Power on	
6	Temperature Cycle	-30°C —————> 80°C 30min 5min 30min after 5 cycle, Restore 2H at 25°C Power off	

Note: Operation: Supply 2.8V for logic system.

The inspection terms after reliability test, as below

ITEM	Inspection
Contrast	CR>50%
IDD	IDD<200%
Brightness	Brightness>60%
Color Tone	Color Tone+/-0,05



9. Precautions for Use of LCD Modules

9.1 Handling Precautions

9.1.1 The display panel is made of glass. Do not subject it to a mechanical shock by dropping it from a high place, etc.

9.1.2 If the display panel is damaged and the liquid crystal substance inside it leaks out, be sure not to get any in your mouth, if the substance comes into contact with your skin or clothes, promptly wash it off using soap and water.

9.1.3 Do not apply excessive force to the display surface or the adjoining areas since this may cause the color tone to vary.

9.1.4 The polarizer covering the display surface of the LCD module is soft and easily scratched. Handle this polarizer carefully.

9.1.5 If the display surface is contaminated, breathe on the surface and gently wipe it with a soft dry cloth. If still not completely clear, moisten cloth with one of the following solvents:

- Isopropyl alcohol
- Ethyl alcohol

Solvents other than those mentioned above may damage the polarizer. Especially, do not use the following:

- Water
- Ketone
- Aromatic solvents

9.1.6 Do not attempt to disassemble the LCD Module.

9.1.7 If the logic circuit power is off, do not apply the input signals.

9.1.8 To prevent destruction of the elements by static electricity, be careful to maintain an optimum work environment.

a. Be sure to ground the body when handling the LCD Modules.

b. Tools required for assembly, such as soldering irons, must be properly ground.

c. To reduce the amount of static electricity generated, do not conduct assembly and other work under dry conditions.

d. The LCD Module is coated with a film to protect the display surface. Be care when peeling off this protective film since static electricity may be generated.



9.2 Storage precautions

9.2.1 When storing the LCD modules, avoid exposure to direct sunlight or to the light of fluorescent lamps.

9.2.2 The LCD modules should be stored under the storage temperature range. If the LCD modules will be stored for a long time, the recommend condition is:

Temperature : $0^{\circ}\text{C} \sim 40^{\circ}\text{C}$

Relatively humidity: $\leq 80\%$

9.2.3 The LCD modules should be stored in the room without acid, alkali and harmful gas.

9.3 The LCD modules should be no falling and violent shocking during transportation, and also should avoid excessive press, water, damp and sunshine.

END