



PRODUCT SPECIFICATIONS

For Customer: _____

: APPROVAL FOR SPECIFICATION

Customer Model No. _____

: APPROVAL FOR SAMPLE

Module No.: PV03405D0130F

Date : 2023-05-31

Table of Contents

No.	Item	Page
1	Cover Sheet(Table of Contents)	P1
2	Revision Record	P2
3	General Specifications	P3
4	Outline Drawing	P4
5	Absolute Maximum Ratings	P5
6	Electrical Specifications	P6-P12
7	Optical Characteristics	P13-P16
8	Precautions for Use of LCD Modules	P17-P18

For Customer's Acceptance:

Approved By	Comment

PREPARED	CHECKED	VERIFIED BY QA DEPT	VERIFIED BY R&D DEPT
NIKOLA			



3. General Specifications

PV03405D0130F is a TFT-LCD module. It is composed of a TFT-LCD panel, driver IC, FPC, a back light unit. The 3.4'' display area contains 800x (RGB)x 800 pixels and can display up to 16.7M colors. This product accords with ROHS environmental Criterion.

Item	Contents	Unit	Note
LCD Type	TFT	-	
Display color	16.7M	-	1
Viewing Direction	ALL	O'Clock	
Operating temperature	-30~+80	°C	
Storage temperature	-30~+80	°C	
Module size	Refer to outline drawing	mm	2
Active Area(W×H)	87.6X87.6	mm	
Number of Dots	800 (RGB) X800	dots	
TFT Driver IC	ILI9881C	-	
Power Supply Voltage	2.8	V	
Backlight	5s2p-LEDs	pcs	
Weight	---	g	
Interface	MIPI	-	

Note 1: Color tune is slightly changed by temperature and driving voltage.

Note 2: Without FPC and Solder.



4. Outline Drawing

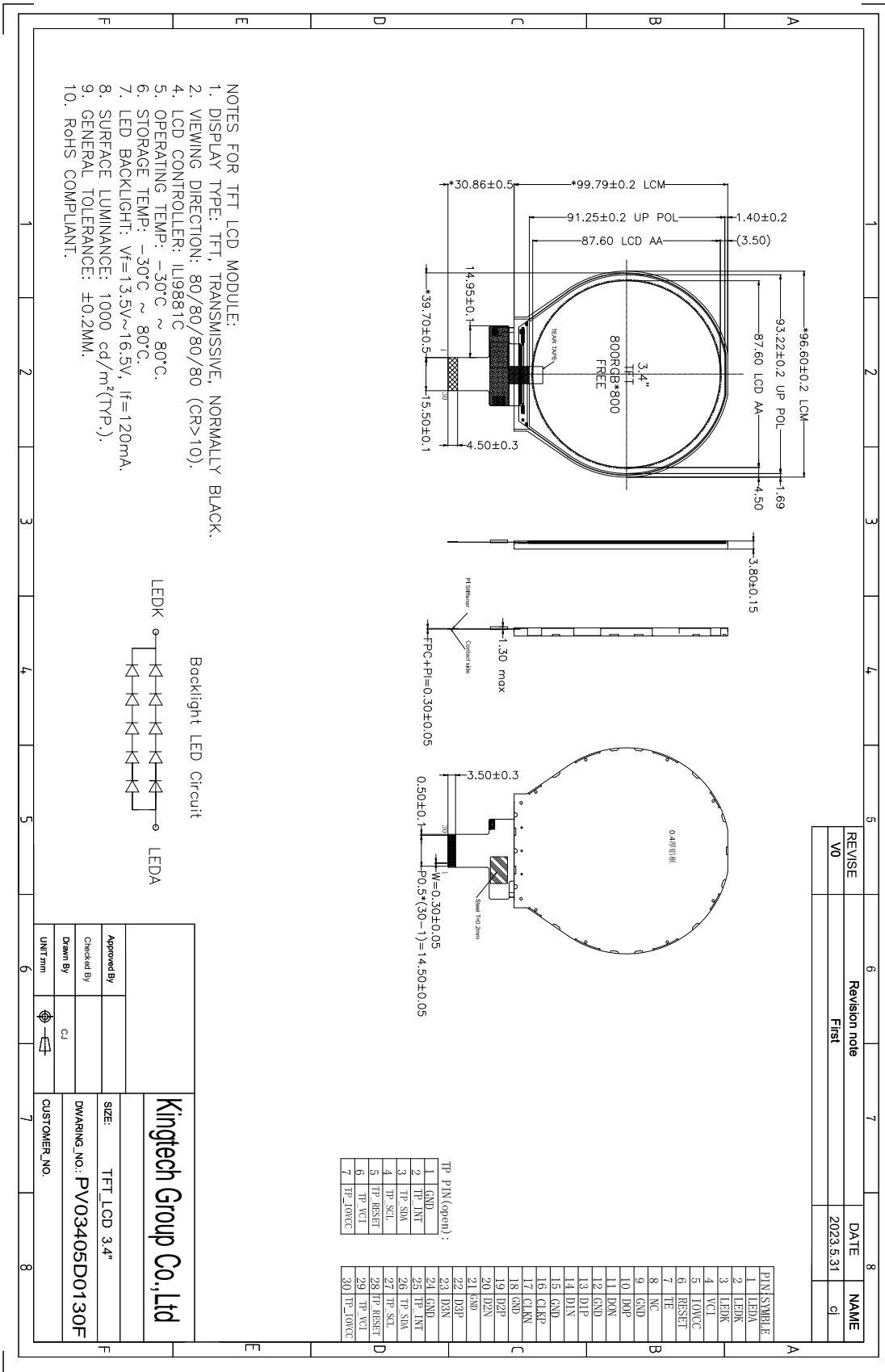

REVISE	Revision note	DATE	NAME
V0	First	2023.5.31	cl

Approved By		SIZE:	TFT LCD 3.4"
Checked By		DWARING NO.:	PV03405D0130F
Drawn By	CJ	CUSTOMER NO.	
UNIT/mm			

Kingtech Group Co., Ltd



5. Absolute Maximum Ratings($T_a=25^\circ\text{C}$)

5.1 Electrical Absolute Maximum Ratings.($V_{SS}=0\text{V}$, $T_a=25^\circ\text{C}$)

Item	Symbol	Min.	Max.	Unit	Note
Power Supply Voltage	V _{CI}	-0.3	6.5	V	1, 2
Power Supply Voltage	IOVCC	-0.3	3.3	V	1, 2

Notes:

1. If the module is above these absolute maximum ratings. It may become permanently damaged. Using the module within the following electrical characteristic conditions are also exceeded, the module will malfunction and cause poor reliability.
2. $V_{CI} > V_{SS}$ must be maintained.
3. Please be sure users are grounded when handing LCD Module.

5.2 Environmental Absolute Maximum Ratings.

Item	Storage		Operating		Note
	MIN.	MAX.	MIN.	MAX.	
Ambient Temperature	-30°C	80°C	-30°C	80°C	1,2
Humidity	-	-	-	-	3

1. The response time will become lower when operated at low temperature.
2. Background color changes slightly depending on ambient temperature.
The phenomenon is reversible.
3. $T_a < 40^\circ\text{C}$:85%RH MAX.
 $T_a > 40^\circ\text{C}$:Absolute humidity must be lower than the humidity of 85%RH at 40°C .



6. Electrical Specifications

6.1 Electrical characteristics (V_{SS}=0V, T_a=25 °C)

Parameter	Symbol	Condition	Min	Typ	Max	Unit	Note
Analog Power supply	V _{CI}	T _a =25°C	2.5	2.8	6.0	V	
Digital Power supply	IOVCC	T _a =25°C	1.75	2.8	3.3		
Input voltage	'H'	V _{IH}	T _a =25°C	0.7*IOVCC	-	IOVCC	V
	'L'	V _{IL}	T _a =25°C	0	-	0.3*IOVCC	V

6.2 LED backlight specification (V_{SS}=0V, T_a=25 °C)

Item	Symbol	Condition	Min	Typ	Max	Unit	Note
Supply voltage	V _f	I _f =120mA	-	15	-	V	
Uniformity	Δ Bp	I _f =120mA	75	-	-	%	
Life Time	time	I _f =120mA	20K	30K	-	hours	1

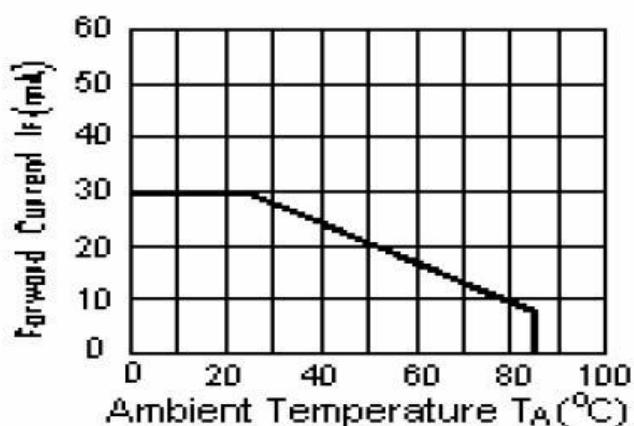

Note 1: Brightness to be decreased to 50% of the initial value at ambient temperature T_A=25 °C



6.3 Interface signals

Pin No.	Symbol	I/O	Function	Note
1	LEDA	P	LED back light(Anode).	
2-3	LEDK	P	LED back light(Cathode).	
4	VCI	P	Analog Power supply	
5	IOVCC	P	Digital Power supply	
6	RESET	I	Reset pin, Active Low.	
7	TE	O	Tearing effect output pin	
7	GND	P	Ground.	
8	NC	-	NO connect.	
9	GND	P	Ground.	
10	D0P	I	MIPI differential data0+ input.	
11	D0N	I	MIPI differential data0- input.	
12	GND	P	Ground.	
13	D1P	I	MIPI differential data1+ input.	
14	D1N	I	MIPI differential data1- input.	
15	GND	P	Ground.	
16	CLKP	I	MIPI CLOCK+differential signal input .	
17	CLKN	I	MIPI CLOCK- differential signal input.	
18	GND	P	Ground.	
19	D2P	I	MIPI differential data2+ input.	
20	D2N	I	MIPI differential data2- input.	
21	GND	P	Ground.	
22	D3P	I	MIPI differential data3+ input.	
23	D3N	I	MIPI differential data3-input.	
24	GND	P	Ground.	
25	TP_INT	-	NO connect.	
26	TP_SDA	-	NO connect.	
27	TP_SCL	-	NO connect.	
28	TP_RESET	-	NO connect.	
29	TP_VCI	-	NO connect.	
30	TP_IOVCC	-	NO connect.	



6.4 AC Characteristics

6.4.1 DSI Timing Characteristics

6.4.1.1 High Speed Mode-Clock Channel Timing

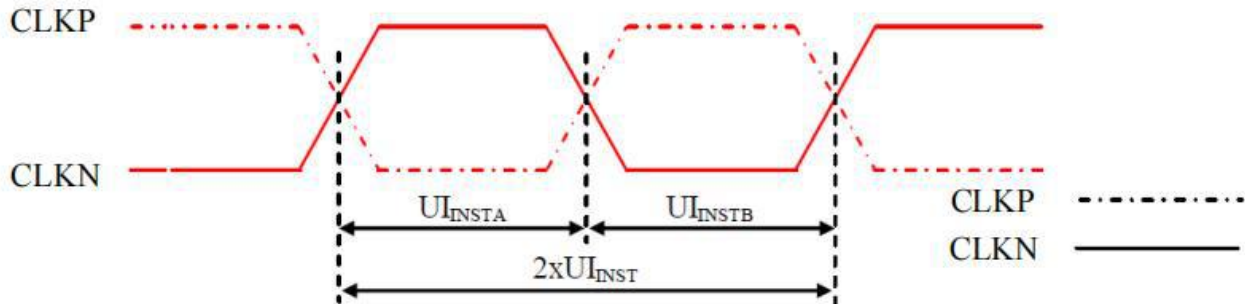

Figure 118: DSI Clock Channel Timing

Table 38: DSI Clock Channel Timing

Signal	Symbol	Parameter	Min	Max	Unit
CLKP/N	$2xUI_{INST}$	Double UI instantaneous	4	25	ns
CLKP/N	UI_{INSTA}, UI_{INSTB} (Note 1)	UI instantaneous Half	2 (Note 2)	12.5	ns

Notes:

1. $UI = UI_{INSTA} = UI_{INSTB}$
2. Define the minimum value of 24 UI per Pixel, see Table 39.

Table 39: Limited Clock Channel Speed

Data type	Two Lanes speed	Three Lanes speed	Four Lanes speed
Data Type = 00 1110 (0Eh), RGB 565, 16 UI per Pixel	566 Mbps	433 Mbps	366 Mbps
Data Type = 01 1110 (1Eh), RGB 666, 18 UI per Pixel	637 Mbps	487 Mbps	412 Mbps
Data Type = 10 1110 (2Eh), RGB 666 Loosely, 24 UI per Pixel	850 Mbps	650 Mbps	550 Mbps
Data Type = 11 1110 (3Eh), RGB 888, 24 UI per Pixel	850 Mbps	650 Mbps	550 Mbps

6.4.1.2 High Speed Mode-Data Clock Channel Timing

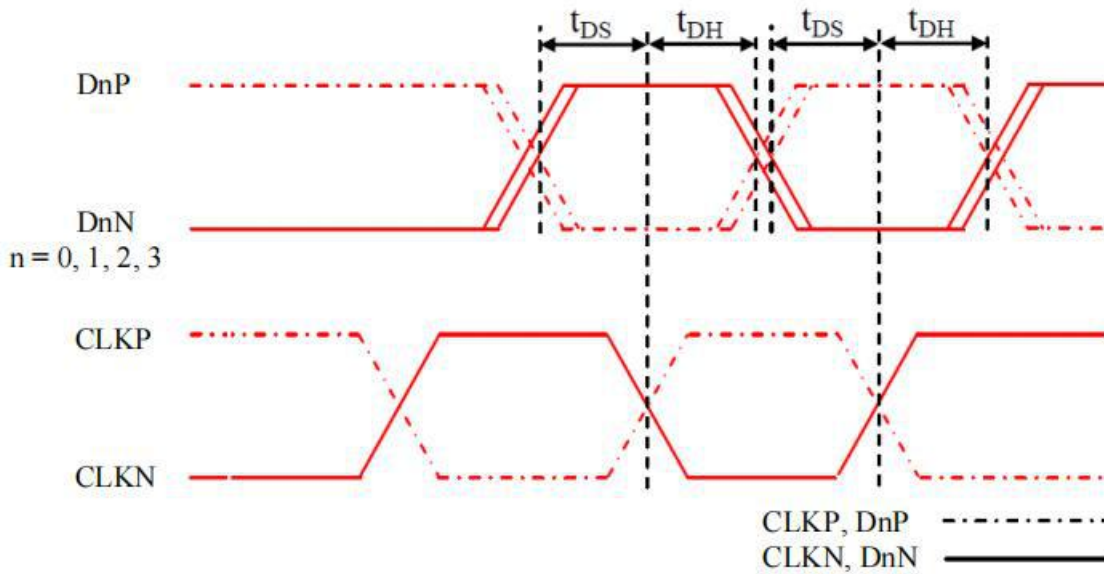

Signal	Symbol	Parameter	Min	Max
DnP/N , n=0 and 1	t_{DS}	Data to Clock Setup time	0.15xUI	-
	t_{DH}	Clock to Data Hold Time	0.15xUI	-

6.4.1.3 High Speed Mode-Rising and Falling Timings

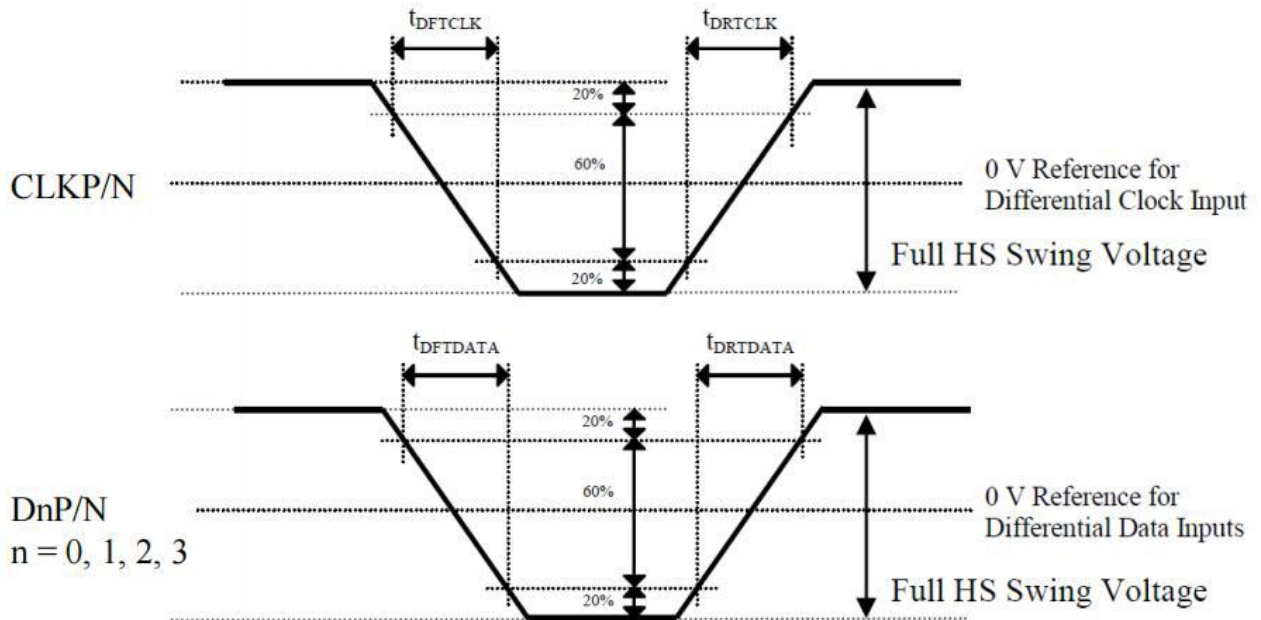



Parameter	Symbol	Condition	Specification		
			Min	Typ	Max
Differential Rise Time for Clock	t_{DRTCLK}	CLKP/N	150 ps	-	0.3UI (Note)
Differential Rise Time for Data	$t_{DRTDATA}$	DnP/N n=0 and 1	150 ps	-	0.3UI (Note)
Differential Fall Time for Clock	t_{DFTCLK}	CLKP/N	150 ps	-	0.3UI (Note)
Differential Fall Time for Data	$t_{DFTDATA}$	DnP/N n=0 and 1	150 ps	-	0.3UI (Note)

Note: The display module has to meet timing requirements, which are defined for the transmitter (MCU) on MIPI D-Phy standard.

6.4.1.4 Low Speed Mode - Bus Turn Around

Signal	Symbol	Description	Min	Max	Unit
D0P/N	T_{LPXM}	Length of LP-00, LP-01, LP-10 or LP-11 periods MCU → Display Module (ILI9881C)	50	75	ns
D0P/N	T_{LPXD}	Length of LP-00, LP-01, LP-10 or LP-11 periods Display Module (ILI9881C) → MCU	50	75	ns
D0P/N	$T_{TA-SURED}$	Time-out before the Display Module (ILI9881C) starts driving	T_{LPXD}	$2xT_{LPXD}$	ns

Table 43: Low Power State Period Timings – B

Signal	Symbol	Description	Time	Unit
D0P/N	$T_{TA-GETD}$	Time to drive LP-00 by Display Module (ILI9881C)	$5xT_{LPXD}$	ns
D0P/N	T_{TA-GOD}	Time to drive LP-00 after turnaround request - MCU	$4xT_{LPXD}$	ns



6.4.1.5 Timing for DSI video mode

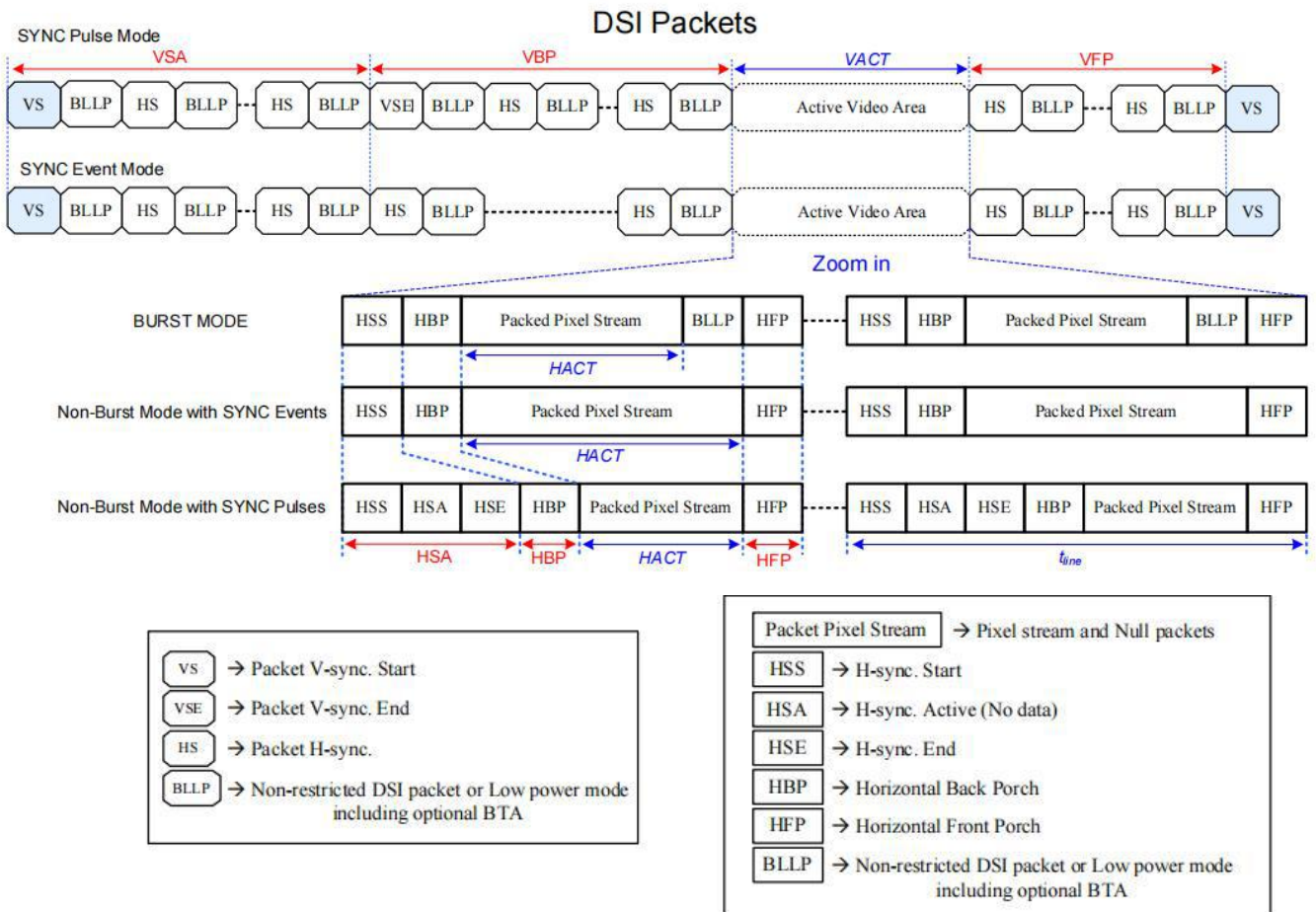

Parameters	Symbols	Min.	Typ.	Max.	Units
Vertical sync. active	VSA	TBD	TBD	-	Line
Vertical Back Porch	VBP	TBD	TBD	-	Line
Vertical Front Porch	VFP	TBD	TBD	-	Line
Active lines per frame	VACT	-	1280	-	Line
Horizontal sync. active	HSA	TBD	TBD	-	Pixel
Horizontal Back Porch	HBP	TBD	TBD	-	Pixel
Horizontal Front Porch	HFP	TBD	TBD	-	Pixel
Active pixels per line	HACT	-	800	-	Pixel
Line time	t_{line}	TBD		-	bps/lane
Bit rate	BR_{bps}	200		Note 5	Line



1 UI=1/Bit rate

HAS(pixel)= (tHSA*lane number) / (UI* pixel format)

HBP(pixel)= (tHBP*lane number) / (UI* pixel format)

HFP(pixel)= (tHFP*lane number) / (UI* pixel format)

$$\text{Frame Rate} = \frac{\text{BR}_{\text{bps}} \times \text{Lane}_{\text{num}}}{(\text{VACT}+\text{VSA}+\text{VBP}+\text{VFP}) \times (\text{HACT}+\text{HSA}+\text{HBP}+\text{HFP}) \times \text{Pixel Format}}$$

Example : BR_{bps} = 457Mbps/lane, 1UI=2.1883ns, Frame rate=60Hz, VACT=1280, VSA=2, VBP=30, VFP=20, HACT=720, HSA=33, HBP=100, HFP=100, Lane_{num}=4(lane), Pixel Format=24(bit).

Note:

1. Lane_{num}: Data lane of MIPI-DSI.
2. Pixel Format: Please reference to "4.1DSI System Interface".
3. The formula exists slightly error because of the host-transmission way.
4. The best frame rate setting : 2 data lanes : 50~60 Hz / 3 data lanes : 50~70 Hz / 4 data lanes : 50~70 Hz.
5. Please reference to "Table 39: Limited Clock Channel Speed"

6.4.2 Reset Timing

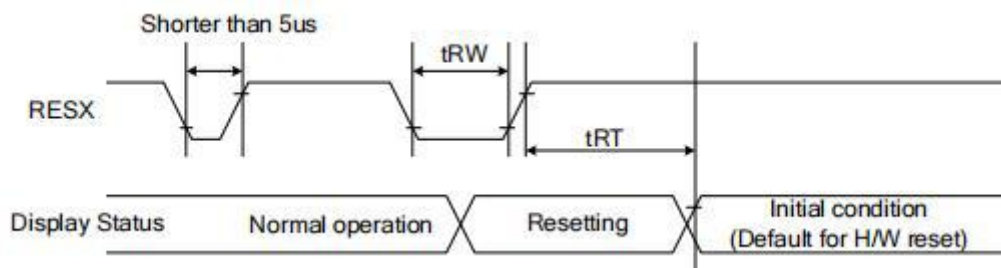

Signal	Symbol	Parameter	Min	Max	Unit
RESX	tRW	Reset pulse duration	10		uS
	tRT	Reset cancel		5 (note 1,5) 120 (note 1,6,7)	mS



Notes:

1. The reset cancel also includes required time for loading ID bytes, VCOM setting and other settings from EEPROM to registers. This loading is done every time when there is H/W reset cancel time (t_{RT}) within 5 ms after a rising edge of RESX.
2. Spike due to an electrostatic discharge on RESX line does not cause irregular system reset according to the Table 48.

Table 48: Reset Descript

RESX Pulse	Action
Shorter than 5us	Reset Rejected
Longer than 10us	Reset
Between 5us and 10us	Reset starts

3. During the Resetting period, the display will be blanked (The display enters the blanking sequence, which maximum time is 120 ms, when Reset Starts in the Sleep Out mode. The display remains the blank state in the Sleep In mode.) and then return to Default condition for Hardware Reset.
4. Spike Rejection can also be applied during a valid reset pulse, as shown below:

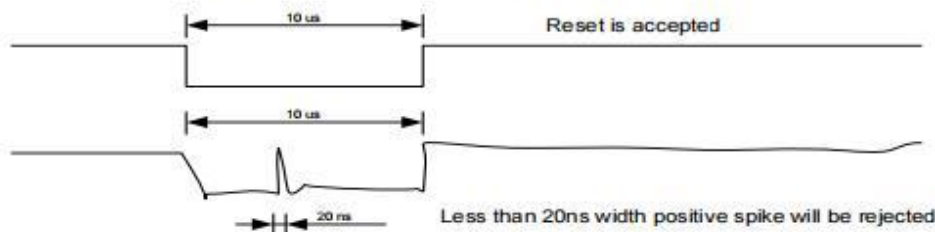

Figure 125: Positive Noise Pulse during Reset Low

5. When Reset applied during Sleep In Mode.
6. When Reset applied during Sleep Out Mode.
7. It is necessary to wait 5msec after releasing RESX before sending commands. Also Sleep Out command cannot be sent for 120msec.



7. Optical Characteristics

Item	Symbol	Condition	Min.	Typ.	Max.	Unit	Note	
Brightness	Bp	$\theta=0^\circ$	800	1000	-	Cd/m ²	1	
Uniformity	ΔBp	$\Phi=0^\circ$	75	-	-	%	1,2	
Viewing Angle	3:00	Cr \geq 10	-	85	-	Deg	3	
	6:00		-	85	-			
	9:00		-	85	-			
	12:00		-	85	-			
Contrast Ratio	Cr	$\theta=0^\circ$ $\Phi=0^\circ$	1000	1200	-	-	4	
Response Time	T _r +T _f		-	30	35	ms	5	
Color of CIE Coordinate	W	x	$\theta=0^\circ$ $\Phi=0^\circ$	Typ -0.05	Typ +0.05	-	1,6	
		y				-		
	R	x				0.322		-
		y				0.332		-
	G	x				0.661		-
		y				0.323		-
	B	x				0.274		-
		y				0.593		-
S	x	0.134	-					
	y	0.124	-					
NTSC Ratio	S	-	70	-	%			

Note: The parameter is slightly changed by temperature, driving voltage and materiel

Note 1: The data are measured after LEDs are turned on for 5 minutes. LCM displays full white. The brightness is the average value of 9 measured spots. Measurement equipment BM-7 (Φ 5mm)

Measuring condition:

- Measuring surroundings: Dark room.
- Measuring temperature: T_a=25 °C.
- Adjust operating voltage to get optimum contrast at the center of the display.

Measured value at the center point of LCD panel after more than 5 minutes while backlight



turning on.

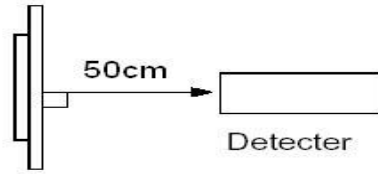

Note 2: The luminance uniformity is calculated by using following formula.

$$\Delta Bp = Bp (\text{Min.}) / Bp (\text{Max.}) \times 100 (\%)$$

$Bp (\text{Max.})$ = Maximum brightness in 9 measured spots

$Bp (\text{Min.})$ = Minimum brightness in 9 measured spots.

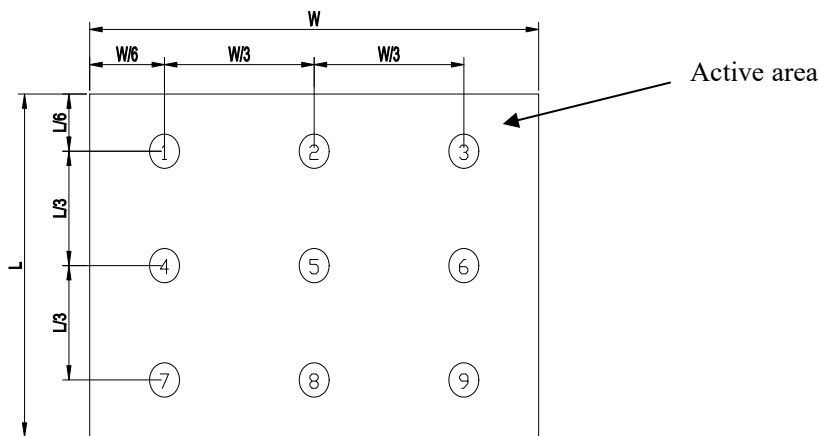

Note 3: The definition of viewing angle:

Refer to the graph below marked by ϑ and ϕ

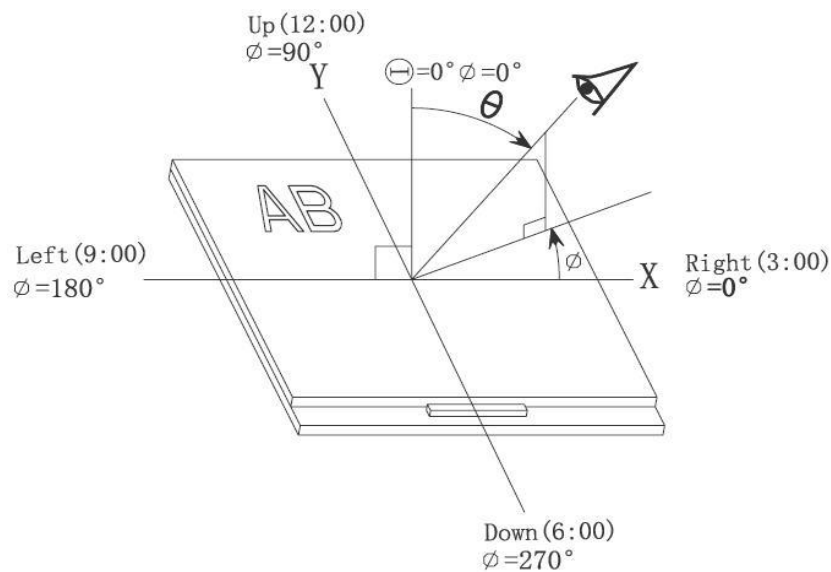

Note 4: Definition of contrast ratio.(Test LCD using DMS501)

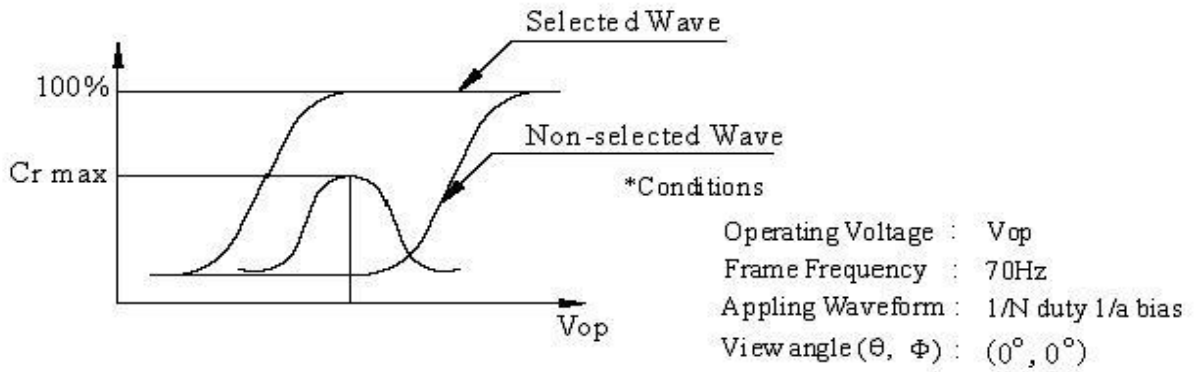

$$\text{Contrast ratio}(Cr) = \frac{\text{Brightness of selected dots}}{\text{Brightness of non-selected dots}}$$

Note 5: Definition of Response time. (Test LCD using DMS501):

The output signals of photo detector are measured when the input signals are changed from "black" to "white" (falling time) and from "white" to "black" (rising time), respectively. The response time is defined as the time interval between the 10% and 90% of amplitudes. Refer to figure as below.

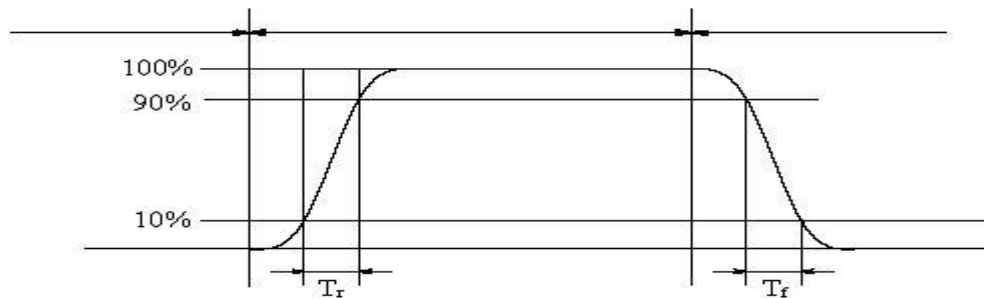

The definition of response time

Note 6: Definition of Color of CIE Coordinate and NTSC Ratio.

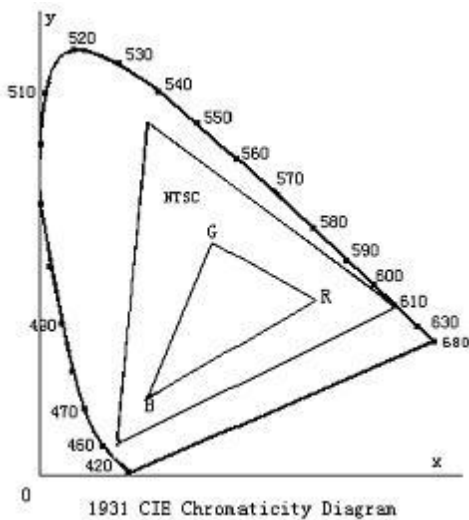

Color gamut:

$$S = \frac{\text{area of RGB triangle}}{\text{area of NTSC triangle}} \times 100\%$$

Note 7: Definition of cross talk.

$$\text{Cross talk ratio}(\%) = \frac{|\text{pattern A Brightness} - \text{pattern B Brightness}|}{\text{pattern A Brightness}} \times 100$$

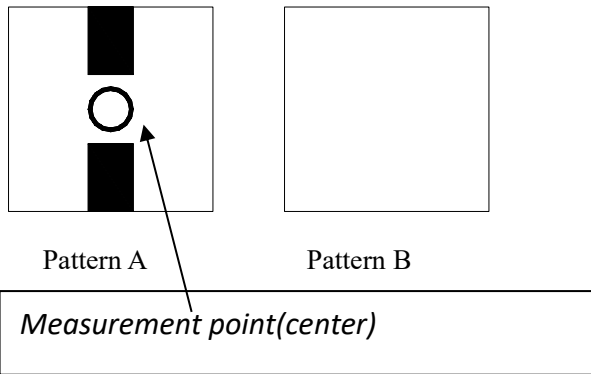

Electric volume value=3F+/-3Hex

8. Precautions for Use of LCD Modules

8.1 Handling Precautions

8.1.1 *The display panel is made of glass. Do not subject it to a mechanical shock by dropping it from a high place, etc.*

8.1.2 *If the display panel is damaged and the liquid crystal substance inside it leaks out, be sure not to get any in your mouth, if the substance comes into contact with your skin or clothes, promptly wash it off using soap and water.*

8.1.3 *Do not apply excessive force to the display surface or the adjoining areas since this may cause the color tone to vary.*

8.1.4 *The polarizer covering the display surface of the LCD module is soft and easily scratched. Handle this polarizer carefully.*

8.1.5 *If the display surface is contaminated, breathe on the surface and gently wipe it with a soft dry cloth. If still not completely clear, moisten cloth with one of the following solvents:*

- Isopropyl alcohol
- Ethyl alcohol

Solvents other than those mentioned above may damage the polarizer. Especially, do not use the following:



— Water

— Ketone

— Aromatic solvents

8.1.6 Do not attempt to disassemble the LCD Module.

8.1.7 If the logic circuit power is off, do not apply the input signals.

8.1.8 To prevent destruction of the elements by static electricity, be careful to maintain an optimum work environment.

a. Be sure to ground the body when handling the LCD Modules.

b. Tools required for assembly, such as soldering irons, must be properly ground.

c. To reduce the amount of static electricity generated, do not conduct assembly and other work under dry conditions.

d. The LCD Module is coated with a film to protect the display surface. Be care when peeling off this protective film since static electricity may be generated.

8.2 Storage precautions

8.2.1 When storing the LCD modules, avoid exposure to direct sunlight or to the light of fluorescent lamps.

8.2.2 The LCD modules should be stored under the storage temperature range. If the LCD modules will be stored for a long time, the recommend condition is:

Temperature : $0^{\circ}\text{C} \sim 40^{\circ}\text{C}$

Relatively humidity: $\leq 80\%$

8.2.3 The LCD modules should be stored in the room without acid, alkali and harmful gas.

8.3 The LCD modules should be no falling and violent shocking during transportation, and also should avoid excessive press, water, damp and sunshine.



9. Reliability Test Items and Criteria

No	Test Item	Test condition	Criterion
1	High Temperature Storage	80°C±2°C 120H Restore 2H at 25°C Power off	1. After testing, cosmetic and electrical defects should not happen. 2. Total current consumption should not be more than twice of initial value.
2	Low Temperature Storage	-30°C±2°C 120H Restore 2H at 25°C Power off	
3	High Temperature Operation	80°C±2°C 120H Restore 2H at 25°C Power on	
4	Low Temperature Operation	-30°C±2°C 120H Restore 4H at 25°C Power on	
5	High Temperature/Humidity Operation	60°C±2°C 90%RH 120H Power on	
6	Temperature Cycle	-30°C → 80°C 30min 5min 30min after 50 cycle, Restore 2H at 25°C Power off	

Note: Operation: Supply 3.3V for logic system.

The inspection terms after reliability test, as below

ITEM	Inspection
Contrast	CR>50%
IDD	IDD<200%
Brightness	Brightness>60%
Color Tone	Color Tone+/-0,05

END